

<sup>TM</sup>  
MULTIframe

<sup>TM</sup>  
MULTIframe

[www.multiframe.at](http://www.multiframe.at)

[www.best-systems.com](http://www.best-systems.com)

[www.penguin.at](http://www.penguin.at)

[www.penguinjapan.com](http://www.penguinjapan.com)

[www.penguinamerica.com](http://www.penguinamerica.com)

best systems gmbh  
rudolf waisenhorn-gasse 13  
1230 wien / vienna - austria  
tel: +43 1 8654082  
office@best-systems.com  
www.best-systems.com

best  
systems

frames & light boxes

# MULTIframe™

Setzen Sie auf maximale FLEXIBILITÄT: Die hochwertigen MULTIframe™ - Aluminiumprofile sind in jeder Größe erhältlich, einfach zu montieren und in kürzester Zeit lieferbar.

Überzeugen Sie durch beste LICHTQUALITÄT: Innovative OSRAM LEDs garantieren eine gleichmäßige brillante Ausleuchtung über die gesamte Fläche. Durch den geringen Energieverbrauch und die wartungsfreie Technik sind MULTIframe™ - Rahmen ein zuverlässiges Produkt für Ihre Anwendungen über viele Jahre hinweg.

Verlassen Sie sich auf bestes KUNDENSERVICE: MULTIframe™ bietet für jede Herausforderung die richtige Lösung. Die hochwertigen Leuchtmittel arbeiten ausfallsfrei und unterliegen - wie auch die Rahmen - einer dreijährigen Garantie.

---

*Focus on maximum ADAPTABILITY: high-quality MULTIframe™ aluminium profiles are available in any size, easy to install and are readily available to ship quickly.*

*Persuade with the best LIGHTING QUALITY: Innovative OSRAM LEDs guarantee a uniform and brilliant illumination for the entire area. Thanks to the low energy use and maintenance-free technology, MULTIframe™ frames will be a reliable product for applications for years to come.*

*Depend on the best CUSTOMER SERVICE: MULTIframe™ offers the right solution for every challenge. These high-quality luminaires and their frames function reliably and come with a 3-year guarantee.*

Überzeugungskraft   SINNESREIZ   Ökofaktor   UBERZEUGUNGSKRAFT   Impulsgeber  
Blickfang   Aufmerksamkeit   IMPULSGEBER   Blickfang   Aufmerksamkeit  
Sinnpolwirkung   SINNESREIZ   Ökofaktor

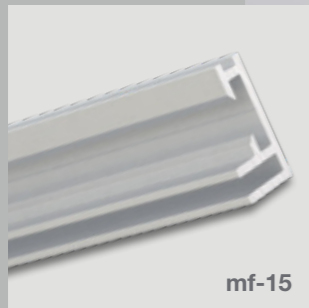

mf-15

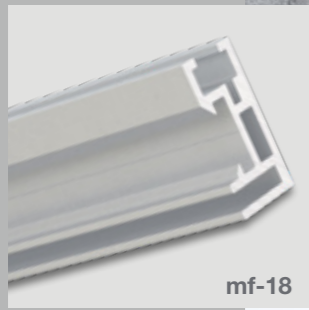

mf-18

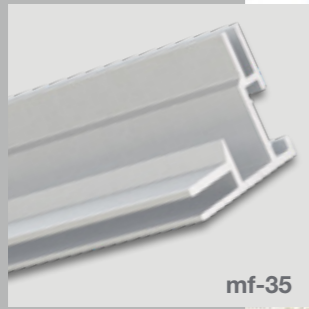

mf-35



mf-65

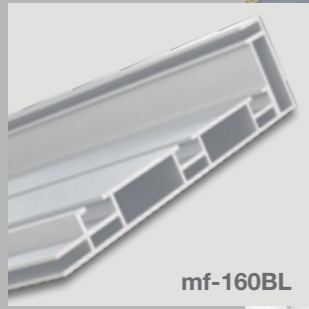

mf-160BL

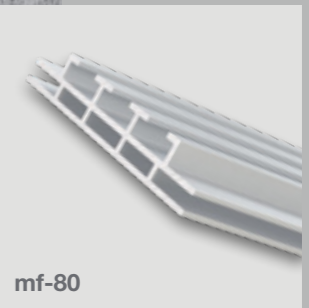

mf-80



mf-120

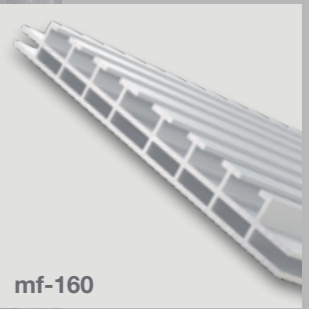

mf-160

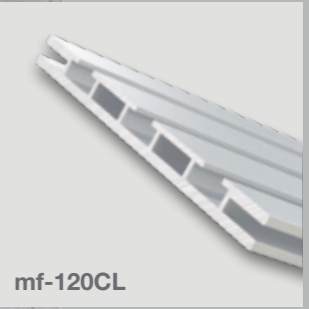

mf-120CL

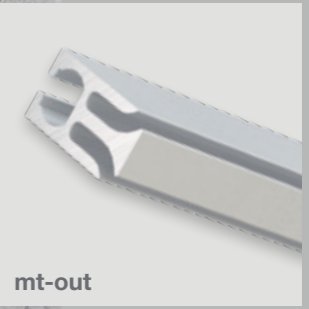

mt-out

frame BASIC

MULTIframe BACKLOAD

MULTIframe BATTERY

MULTItower

MULTIframe SIDE LIGHT

MULTI

MULTIframe SIDE LIGHT

MULTIframe SUPER SLIM

MULTIframe BACKLOAD

MULTIframe BASIC

MULTIframe SUPER SLIM

MULTItower

MULTIframe ALL IN ONE

MULTIframe

# MULTIframe BASIC

## – Rahmenprofile in diversen Bautiefen erhältlich

- Material - silber eloxierte Aluminiumprofile mit Stahlverbindern
- Stoffdruckverspannung mittels Gummilippen
- einfache Montage und schneller Motivwechsel
- Profile in RAL-Farben (Pulverbeschichtung) auf Anfrage erhältlich
- Ersatzteile erhältlich

## – frame profiles available in various widths

- material - silver anodized aluminium profiles with steel connectors
- fabric print attaches to the frame with silicon edging
- easy to assemble and graphics change easily
- profiles in RAL- colours (powder coating) available upon request
- spare parts available

■ mf-80

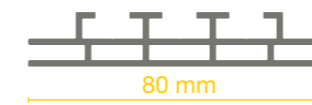

■ mf-120



■ mf-120CL



■ mf-160



■ mf-160BL

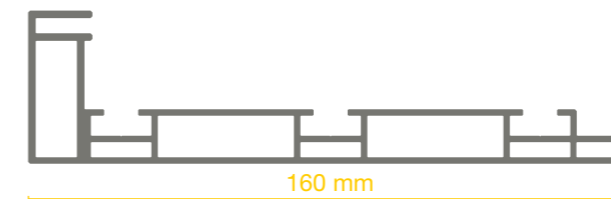

■ mf-15



■ mf-18



■ mf-35



■ mf-65

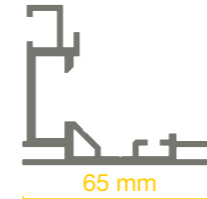

Deckenabhängung vertikal /  
suspension vertical

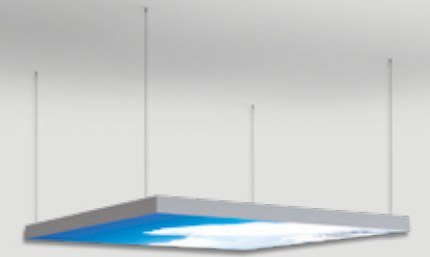

Deckenabhängung horizontal /  
suspension horizontal



Wand- und Deckenmontage /  
wall and ceiling mounting



Wand- und Deckenmontage - Sonderform /  
wall and ceiling mounting - special



Stellwand freistehend /  
free standing display



Deckenring / ceiling ring

# MULTIframe SUPER SLIM



## multi frame - super slim

– dünnster Vollflächen LED Rahmen der Welt

- Rahmenprofil in 2 Bautiefen erhältlich - 35 und 65 mm
- vollflächige, homogene Ausleuchtung dank qualitativ hochwertiger LED Technik mit speziell angepasster Linsenform
- energiesparend durch moderne LED Technik
- Leuchtkraft ca. 45 watt/m<sup>2</sup>, 7000 lm, 1600 cd/m<sup>2</sup>, Farbtemperatur 6500 Kelvin
- Sonderformate möglich
- Wandmontage und Montage in Laibung möglich

– *thinnest full-face LED frame in the world*

- *frame profile available in 2 depths - 35 and 65 mm*
- *full-area, homogeneous illumination thanks to high quality LED technology with specially adapted lens shape*
- *modern LED technology - energy saving*
- *luminance approx. 45 watt/m<sup>2</sup>, 7000 lm, 1600 cd/m<sup>2</sup>, colour temperature 6500 kelvin*
- *custom sizes available*
- *inset wall mounting optional*

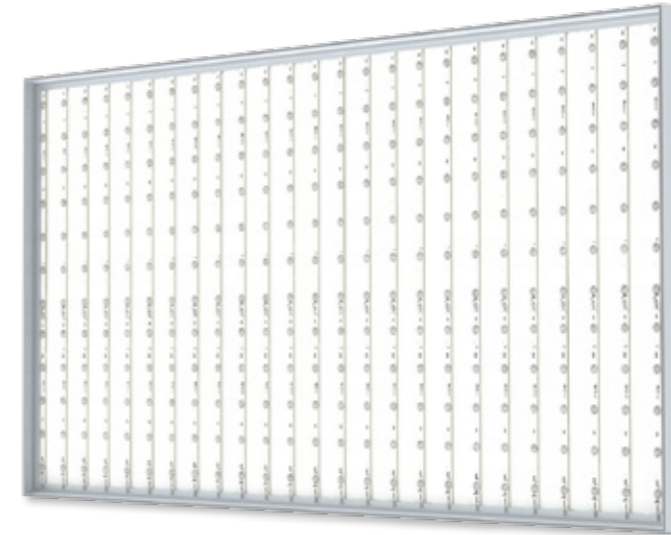

■ Wandmontage / wall mounting

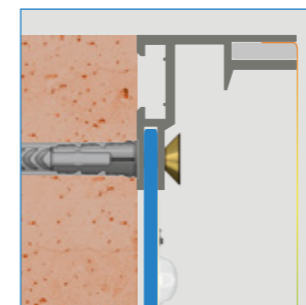

■ Laibung / inset into wall

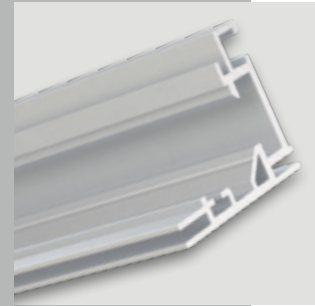
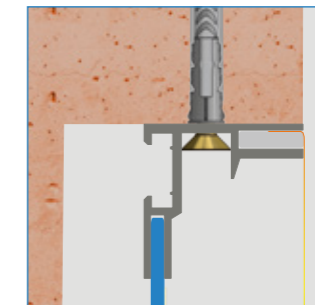

Profildesign mf-35 / profile design mf-35

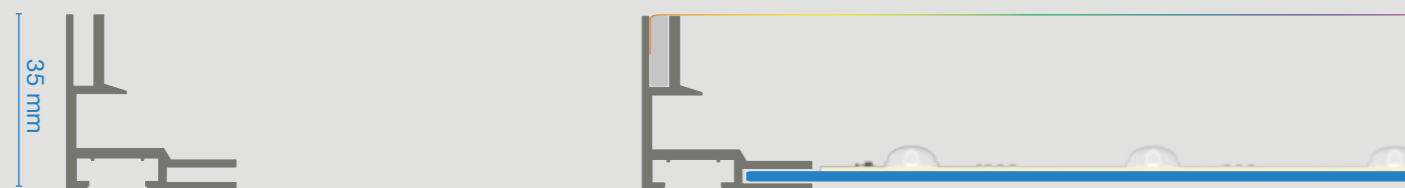

Profildesign mf-65 / profile design mf-65

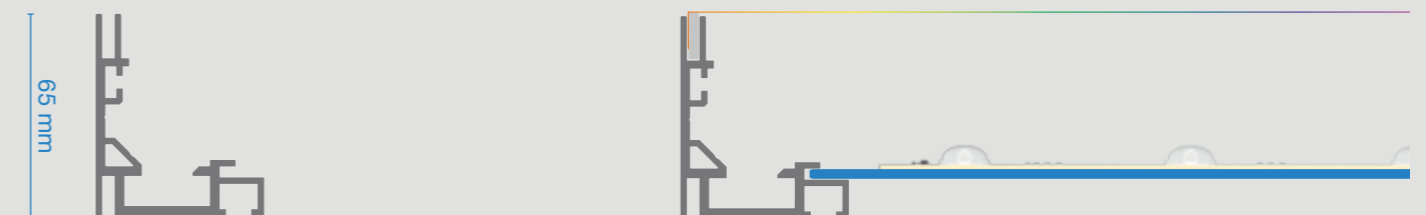

Zubehör /  
accessories

Eckverbinder /  
corner connector

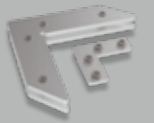

gerader Verbinder /  
straight connector



LED Module /  
LED lights

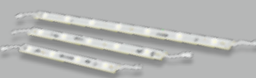

Dimmer / dimmer



Profile in diversen  
Farben erhältlich /  
profiles in various  
colours available



# MULTIframe SIDE LIGHT



## multi frame - side light

### – großformatige ein- & doppelseitige LED Leuchtkästen

- Rahmenprofil in 3 Bautiefen erhältlich - 80 mm, 120 mm und 160 mm
- Beleuchtung mittels seitlicher LED Einstrahlung
- energiesparend durch moderne LED Technik
- Leuchtkraft ca. 2 Watt/LED, 140 lm/Watt, 400 - 750 cd, 6500 Kelvin
- maximale Ausleuchtung bis 300 cm - Baulänge beliebig
- Netzteile im Rahmen verbaut
- auf Anfrage dimmbar

### – single & double sided large format LED light boxes

- frame profile available in 3 dimensions - 80 mm, 120 mm and 160 mm
- LED side illumination
- modern LED technology - energy saving
- luminance approx. 2 watt/LED, 140 lm/watt, 400 - 750 cd, 6500 kelvin
- 2 sides illumination - up to 300 cm wide - length unlimited
- transformers built into the frames
- dimmable LEDs upon request

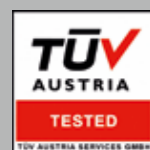
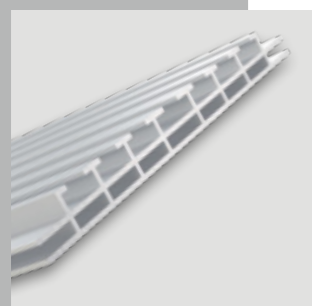
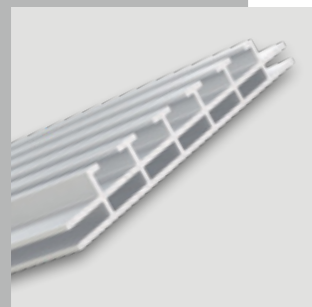
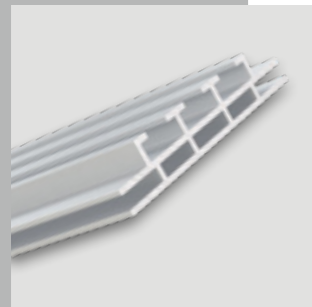
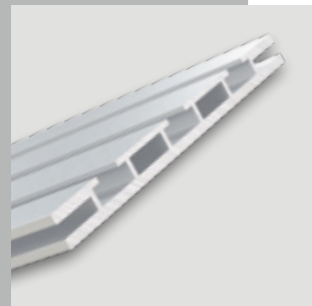

mf-SL-120CL

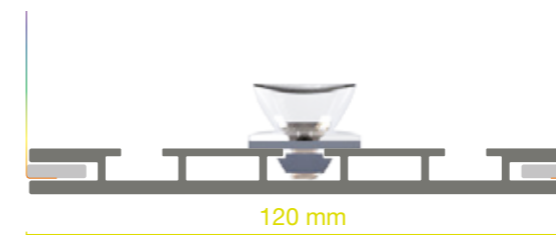

mf-SL-80

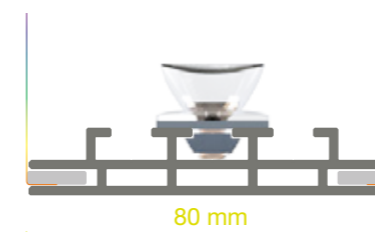

mf-SL-120

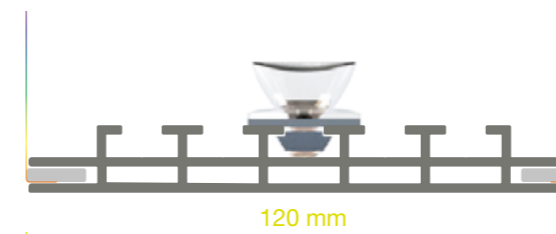

mf-SL-160

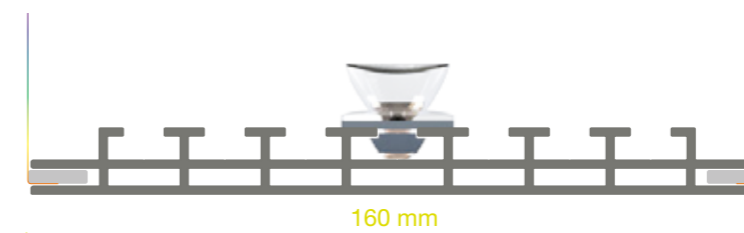

## Zubehör / accessories

Eckverbinder 90° / corner connector 90°



Stellfuß - optional mit Rollen / base - optional with casters

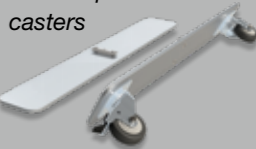

Wandhalterung / wall fixture



Deckenabhängung / ceiling suspension



LED Module / LED lights

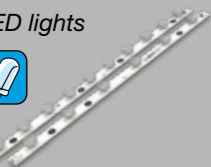

Profile in diversen Farben erhältlich / profiles in various colours available



## Systemdetails / system details

beidseitige, homogene Ausleuchtung dank qualitativ hochwertiger OSRAM LED Technik mit speziell angepasster Linsenform

double sided illumination - even lighting using OSRAM LED technique including a specially adapted lens

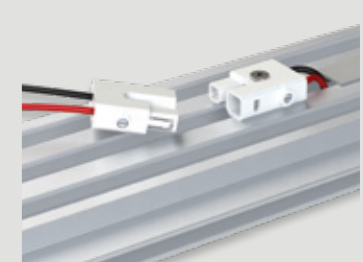
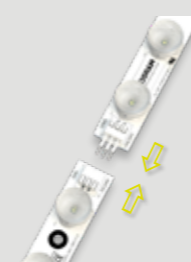

# MULTIframe ALL IN ONE



## multi frame - all in one

### – modulares Leuchtrahmensystem in ABS Transportkoffer

- 1 System 4 Größen
- Bautiefe nur 120 mm
- einfache Montage dank Plug & Play Lichttechnik
- absolut homogene Ausleuchtung durch innovatives Versteifungskonzept
- ABS Transportkoffer BxHxT 39x30x116 cm mit Schaumstoffeinlagen, Rollen und Griff
- ca. 29 kg Transportgewicht

### – modular light box display in ABS hardcase

- 1 system 4 sizes
- depth only 120 mm
- easy installation thanks to plug & play lighting technology
- unique rigid frame design – holds the fabric panel tight for a flat panel with even lighting
- ABS hardcase WxHxD 39x30x116 cm with special foam lining, wheels and handle
- approx. 29 kg transport weight



■ 200x248 cm



■ 100x248 cm



■ 200x200 cm

■ 100x200 cm



## Zubehör / accessories

Eckverbinder 90° / corner connector 90°



gerade Verbinder / straight connector

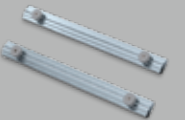

LED Module / LED lights



Systemverlängerung 24 cm / system extension 24 cm



Profile in diversen Farben erhältlich / profiles in various colours available

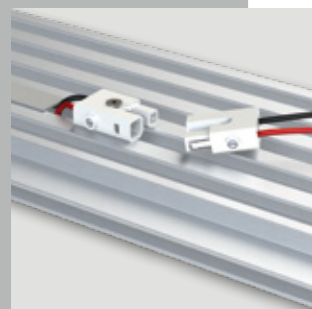
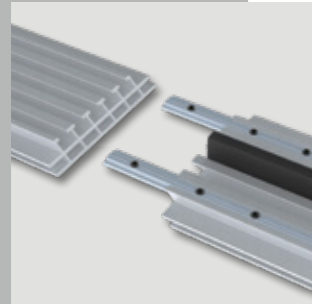
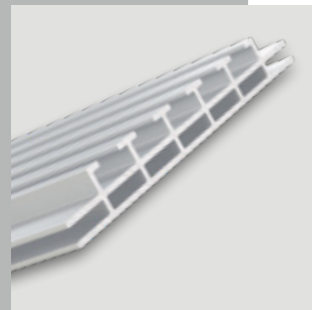

## Profildesign / profile design

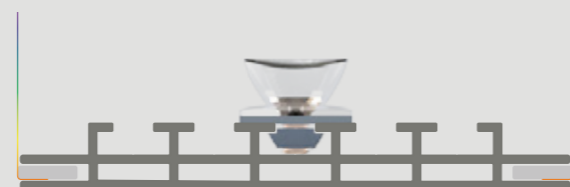
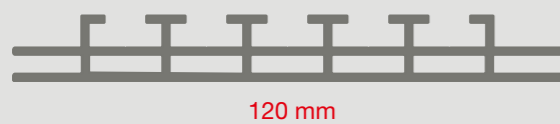

## Koffereinlagen / hardcase with foam lining

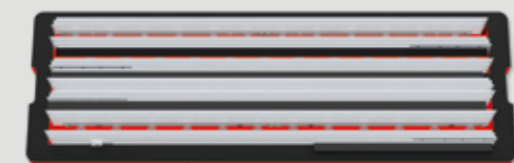

OSRAM  
LED Technology included

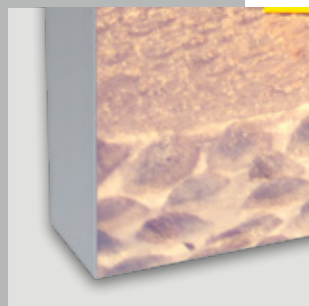
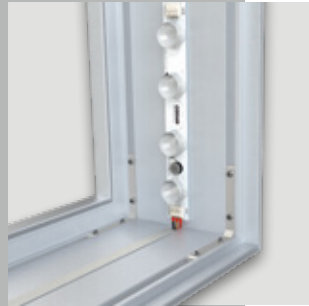
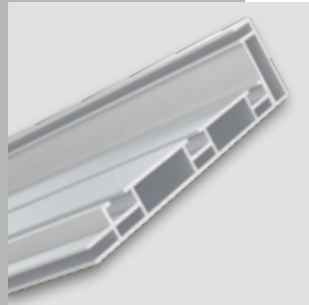

# MULTIframe BACKLOAD



## multi frame - back load

– bestens geeignet für Fixmontage im Schaufenster

- Motivwechsel der beiden Stoffdrucke von einer Seite (Rückseite) möglich
- maximale Ausleuchtung bis 300 cm - Baulänge beliebig
- beidseitige, homogene Ausleuchtung dank qualitativ hochwertiger OSRAM LED Technik mit speziell angepasster Linsenform
- Netzteile im Rahmen verbaut
- auf Anfrage dimmbar
- verwindungssteife Konstruktion

– best for fixed mounting in a shop window

- both graphics change from one side (back)
- 2 sides illumination - up to 300 cm wide - length unlimited
- even lighting illumination - using OSRAM LED technique including a specially adapted lens
- transformers built into the frames
- dimmable LEDs upon request
- rigid construction

OSRAM  
LED Technology included

### Profildesign / profile design



# MULTIframe BATTERY



## multi frame - battery

– mit Akkubetrieb & Stellfüße

- beleuchteter, oberer Rahmen 80x180 cm / 100x180 cm  
unbeleuchteter, unterer Rahmen mit eingebautem Akku 80x40 cm / 100x40 cm
- beidseitige, homogene Ausleuchtung dank qualitativ hochwertiger OSRAM LED Technik mit speziell angepasster Linsenform
- Leuchtkraft ca. 88 Watt
- ca. 4,5 Stunden Leuchtleistung  
mit extern wiederaufladbarem 24 Volt Lithium-Ionen Powerpack (15 Ah)
- alternativ für standardmäßigen Stromanschluss verwendbar

– with battery & bases

- illuminated upper frame 80x180 cm and 100x180 cm  
non-illuminated lower frame with built-in battery 80x40 cm and 100x40 cm
- double sided illumination - even lighting using OSRAM LED technique including a specially adapted lens
- low power consumption 88 watt
- approx. 4,5 hours illumination  
with externally rechargeable 24 volt lithium-ion powerpack (15 Ah)
- useage of standard electricity possible

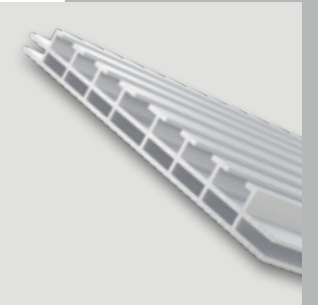

OSRAM  
LED Technology included

### Profildesign / profile design

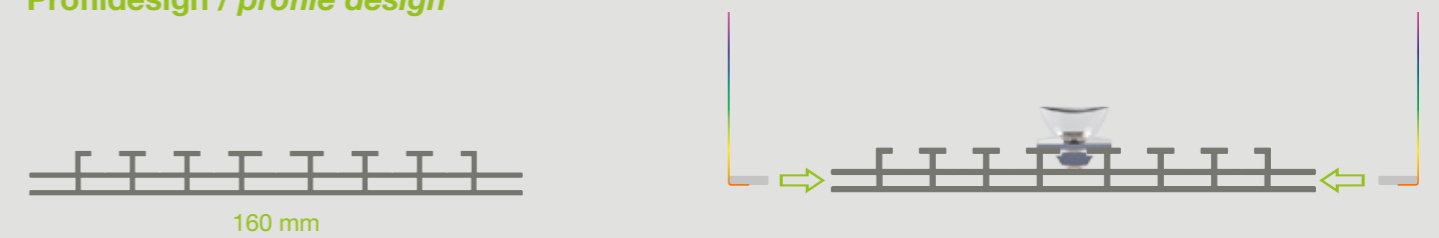



# MULTItower

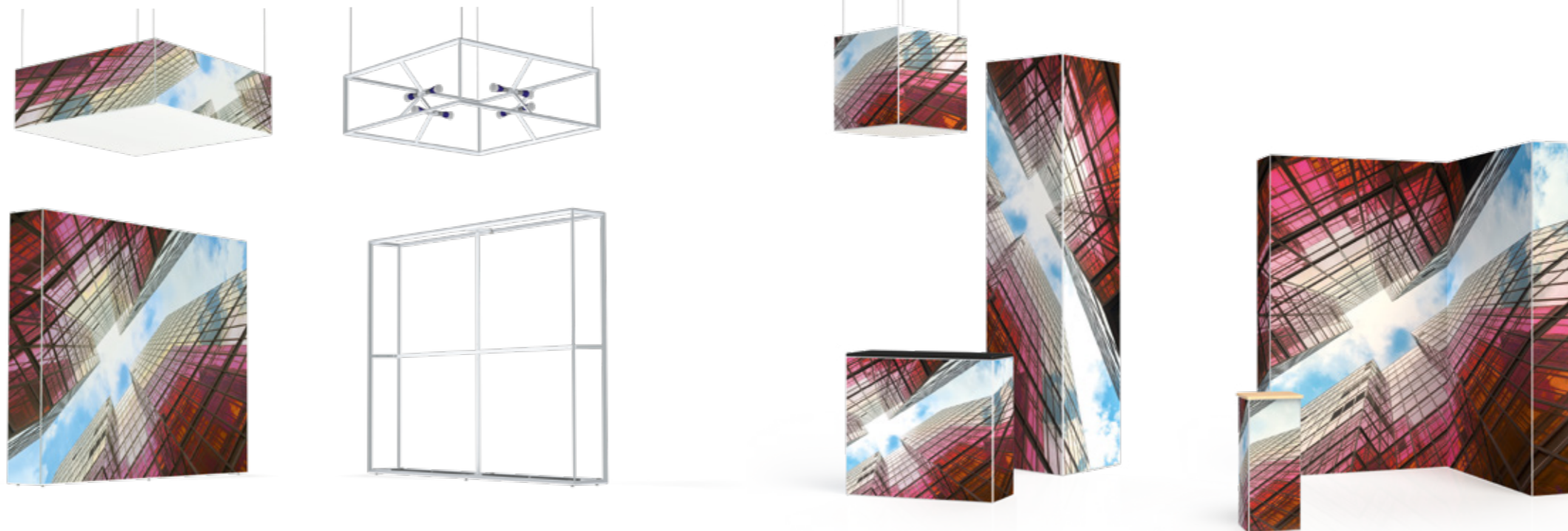

## multi tower

### – Profile speziell zur Konstruktion von 3D Objekten

- Material - silber eloxierte Aluminiumprofile mit Zinkdruckgussverbindern
- Stoffdruckverspannung mittels Gummilippen
- einfache Montage und schneller Motivwechsel
- energiesparend durch moderne LED Technik
- Profile in RAL-Farben (Pulverbeschichtung) auf Anfrage erhältlich

### – profiles specially designed for 3D objects

- material - silver anodized aluminium profiles with zinc die-cast connectors
- fabric print attaches to the frame with silicon edging
- easy to assemble and graphics change easily
- modern LED technology - energy saving
- profiles in RAL-colours (powder coating) available upon request

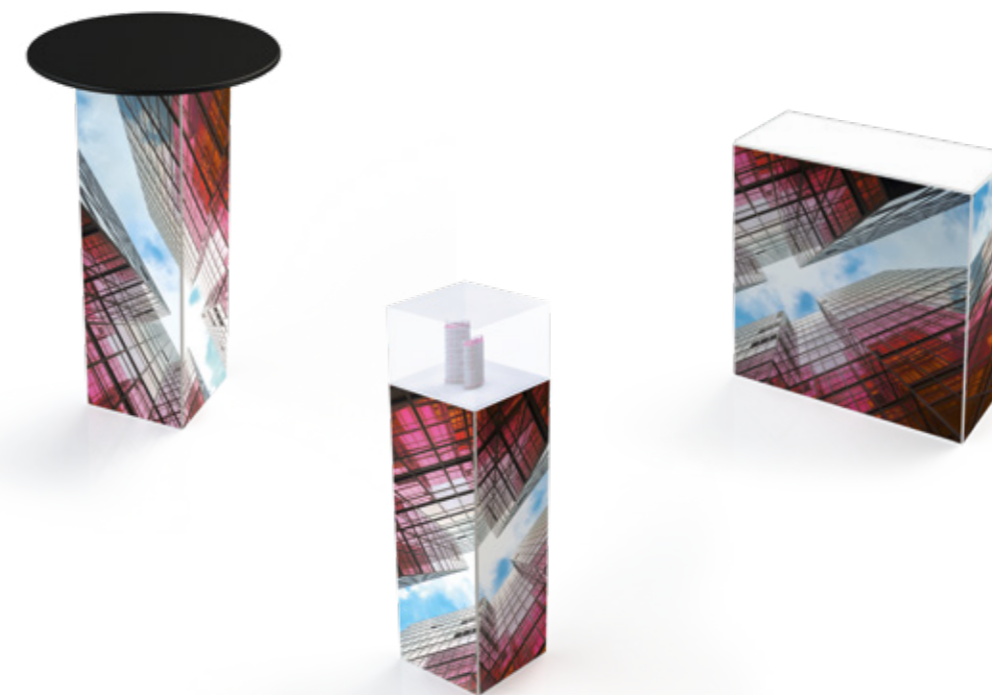

## Zubehör / accessories

Stellfuß  
höhenverstellbar /  
adjustable base



seitliche Einstrahlung /  
edge lighting



LED Lampen /  
LED lamps

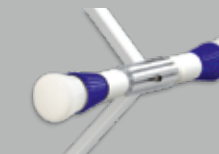

Verstärkungselement /  
crosses to add stability



gerader Verbinder /  
straight connector



Profile in diversen  
Farben erhältlich /  
profiles in various  
colours available



## Profildesign mt-out - Außenecke / profile design mt-out - outside corner

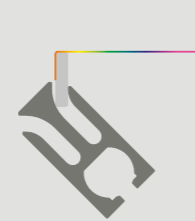

## Profildesign mt-in - Innenecke / profile design mt-in - inside corner

